

Air Driven Liquid Pumps

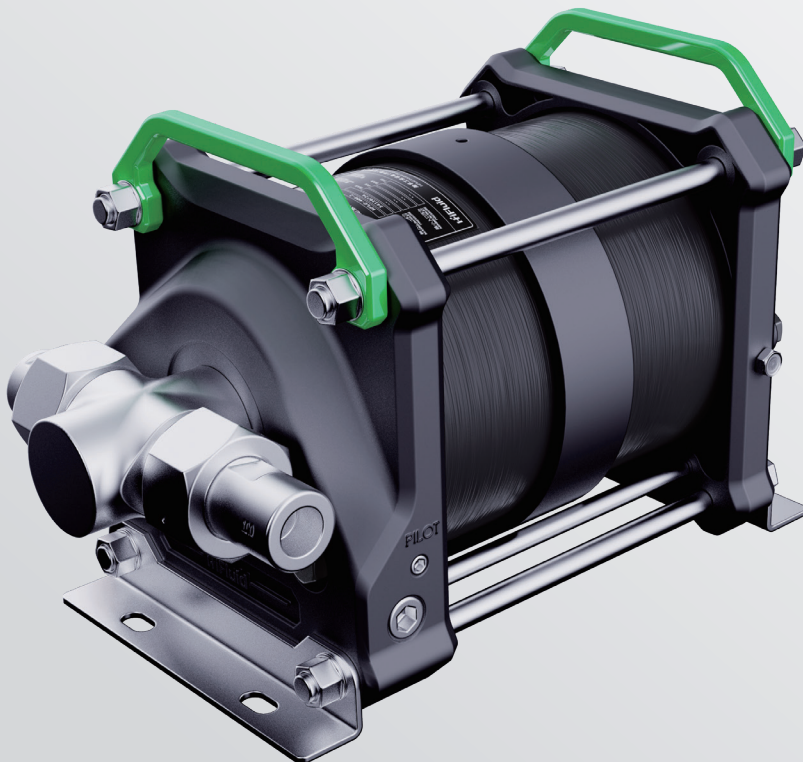



HiFluid, located in Ji'nan, China, national high-tech enterprise, science and technology-based SME, has been focusing on providing safe, stable, intelligent, and customized solutions for advanced ultra-high-pressure fluid applications such as hydrogen compression, high-pressure testing, high-pressure processing (HPP), solid-electrolyte battery production etc. as well as pressure generation unit and control & transfer unit for standard ultra-high-pressure fluid systems since its establishment in 2019. Leveraging its core competencies in design, equipment, and quality assurance, the company is committed to helping customers minimize lifecycle operational costs through energy-saving technologies and extended maintenance intervals.

The company has achieved certifications for ISO 9001 Quality Management System, ISO 14001 Environmental Management System, and ISO 45001 Occupational Health and Safety Management System. We strive to differentiate ourselves from traditional suppliers by embodying the role of consultants and solution providers with our expertise and craftsmanship.

All greatness comes from a brave beginning.

Table of Contents

● — Introduction to HiFluid Air Driven Liquid Pumps	01
● — M Series Air Driven Liquid Pumps	04
● — S Series Air Driven Liquid Pumps	05
● — G Series Air Driven Liquid Pumps	06
● — Selection of HiFluid Air Driven Liquid Pumps	10
● — Installation and Operation Guide for HiFluid Air Driven Liquid Pumps	12
● — Pressure-Flow Rate Curves of HiFluid Air Driven Liquid Pumps	13

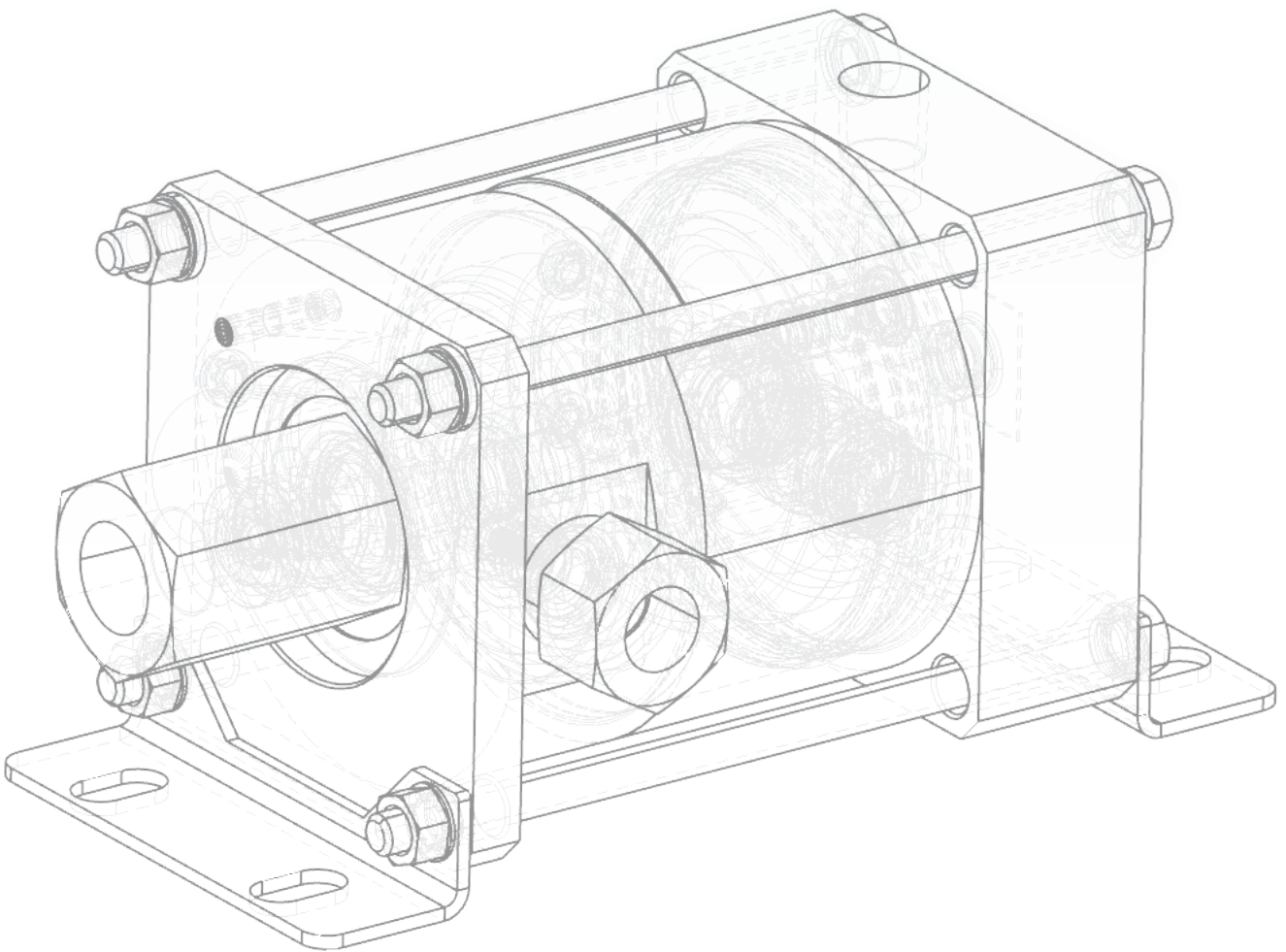

HiFluid air driven liquid pumps are based on the design principle of an oscillating pressure intensifier, when the output pressure drops, it can automatically start to restore the pressure, maintaining the preset pressure level. The pumps are driven with compressed air at 0.3 to 0.8MPa.

Max. output pressure
600MPa

HiFluid air driven liquid pumps can be used for filling oil, water, and various special liquid medium, with a maximum output pressure of up to 600MPa. They play a key role in many application scenarios, especially in explosion-proof areas with high safety requirements.

Key Advantages

- **Flexible Pressure Regulation:** Pressure can be easily adjusted via a manual pressure regulator or pneumatically actuated valve to meet various operational needs.
- **Suitable for Explosion-Proof Environments:** Air Drive Liquid Pumps are driven by compressed air and can be used safely in explosion-proof areas, reducing the risk of explosion and fire.
- **Automatic Start-Stop Function:** The pump will automatically stop when the preset pressure is reached, and will automatically refill pressure when the pressure drops below the preset level.
- **Wide Range of Medium Compatibility:** Air Drive Liquid Pumps are suitable for conveying and boosting most liquids and liquefied gases, with high adaptability.
- **Energy-Saving and Environmentally Friendly:** No power consumption or heat generation during pressure holding periods, good for energy and environment.

Typical Applications

Air driven liquid pumps are widely used in the industrial fields of power control and pressure resistance explosion testing, with a maximum output pressure of up to 600MPa.

- **Pressure Calibration, and Verification:** Used to provide standard hydraulic pressure for calibrating, verifying, and ensuring equipment accuracy.
- **Hydrostatic Pressure and Fatigue Testing:** Used in hydraulic systems to simulate high-pressure conditions for pressure resistance, burst, and fatigue testing.
- **Fluid Pressure Control:** Used to control fluid pressure, ensuring that the fluid flow in the system meets the required standards.
- **Special Medium Handling:** Used for conveying, filling, or handling special liquid mediums, such as chemicals or high-viscosity fluids.
- **High-Pressure Cleaning:** Provides high-pressure liquids for various cleaning applications, ensuring effective cleaning.

Structural Types

HiFluid air drive liquid pumps are available in the following three structural types:



Single-Drive Single-Acting

Single-drive piston, each operating cycle achieves one time boost, compact and lightweight.



Single-Drive Double-Acting

Single-drive piston, each operating cycle achieves two times boost, offering a larger flow rate compared to single-drive single-acting types under the same pressure ratio.



Double-Drive Single-Acting

Double-drive piston, each operating cycle achieves one time boost, offering a larger flow rate compared to single-drive single-acting types under the same pressure ratio, but with higher compressed air consumption.

Double-acting pumps increase the pump capacity by around 50% in comparison to single-acting pumps and reduce the pulsation equally.

Type Coding

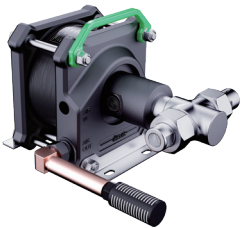
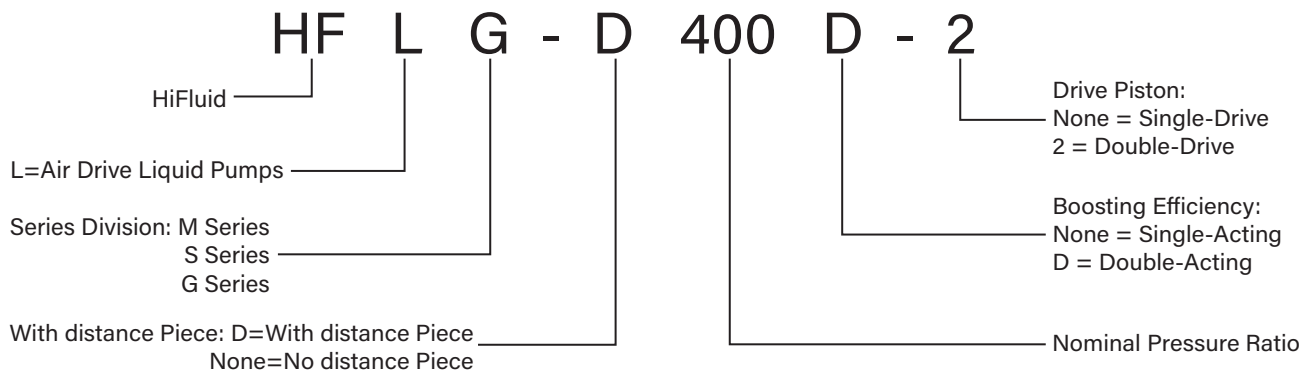

For example: HFLG-D400 is an air driven liquid pump, G series, with distance piece, nominal pressure ratio 1:400, single-acting, single-drive.

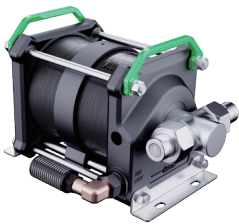

For example: HFLG-100-2 is an air driven liquid pump, G series, without distance piece, nominal pressure ratio 1:100, single-acting, double-drive.

Core Competencies



01 Digitalization

The company is a pioneer in the industry with the introduction of digital services. Users can scan the QR code on the air driven liquid pumps to access relevant electronic documents, making after-sales service more convenient. Moreover, HiFluid plans to further integrate into the global ecosystem through digital marketing, achieving mutual success with stakeholders.

02 Performance and Process

Product development follows the APQP process, with key components optimized through FEA to ensure the optimal matching of product performance and processes.

03 Quality

The production equipments are advanced, and secondary suppliers are managed through process control. Testing equipment is comprehensive, and assembly operations follow standardized processes, ensuring stable and reliable product quality.

04 Sealing

As the core component of the air driven liquid pumps, the sealing structure adopts a self-compensating design, ensuring that air pressure acts on the lip. The higher the medium pressure, the greater the contact pressure on the lip, leading to better sealing performance. The elastomer automatically compensates for lip wear, ensuring seal integrity throughout the product's lifecycle. The sealing sliding ring is made from modified PTFE material with added PI, offering excellent wear resistance and a very low friction coefficient (<0.01), allowing for long-term operation without lubrication and preventing stick-slip even after prolonged downtime. The rubber O-ring is made from modified NBR material with extremely low compression set, ensuring sufficient pre-load pressure on the PTFE lip throughout its lifecycle.

05 Verification

The entire product series has undergone type testing verification to ensure it meets theoretical design specifications. In addition, HiFluid actively collaborates with professional third-party testing organizations such as TÜV Rheinland to complete explosion-proof safety assessments, ensuring that product performance meets EU regulations.

06 Design

Industrial beauty is conveyed to customers through sleek and smooth lines, regular geometric shapes, harmonious color schemes, high-quality material selection, exquisite manufacturing craftsmanship, and meticulous attention to detail.

Selection of HiFluid Air Driven Liquid Pumps—M Series



The M series Air Driven Liquid Pumps are only available in single-drive single-acting type. It provides seven pressure ratios to adapt to different pressure requirements. It is characterized by low energy consumption and high output pressure, which is suitable for working scenarios with high pressure but low flow requirements and tight installation space.

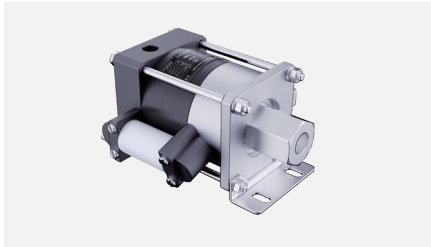

M Series Single-Drive Single-Acting Air Driven Liquid Pump

- Single-Drive Piston, Single-Acting
- Maximum Output Pressure: 94.5MPa (13,700psi)
- Suitable for Air Drive Pressure (P_L) at 0.3 to 0.7MPa (43.5 to 101.5psi)
- Actual Output Pressure = Air Drive Pressure * Pressure Ratio
- Suitable for water, oil, solvents, low-corrosive chemicals, liquefied gases, and other liquid fluids.

Product Parameters

Type	Pressure Ratio	Displacement /Cycle (ml)	Max. Outlet Pressure		Flow Rate (L/min)	Connection Interface			Dimensions (mm)			Weight (kg)
			MPa	psi		Drive Inlet	Medium Inlet	Medium Outlet	A	B	C	
HFLM-7	1:7	10.81	4.9	710	7.35	NPT1/4	NPT3/4	NPT1/2	170	126	83	3.7
HFLM-15	1:15	5.61	10.5	1522	3.81	NPT1/4	NPT3/4	NPT1/2	170	126	83	3.7
HFLM-25	1:25	3.38	17.5	2538	2.29	NPT1/4	NPT3/8	NPT1/4	170	126	83	3.7
HFLM-34	1:34	2.48	23.8	3451	1.68	NPT1/4	NPT3/8	NPT1/4	170	126	83	3.7
HFLM-49	1:49	1.73	34.3	4974	1.17	NPT1/4	NPT3/8	NPT1/4	170	126	83	3.7
HFLM-76	1:76	1.11	53.2	7714	0.75	NPT1/4	NPT3/8	NPT1/4	170	126	83	3.7
HFLM-135	1:135	0.62	94.5	13700	0.42	NPT1/4	NPT3/8	NPT1/4	170	126	83	3.7

Installation Dimensions

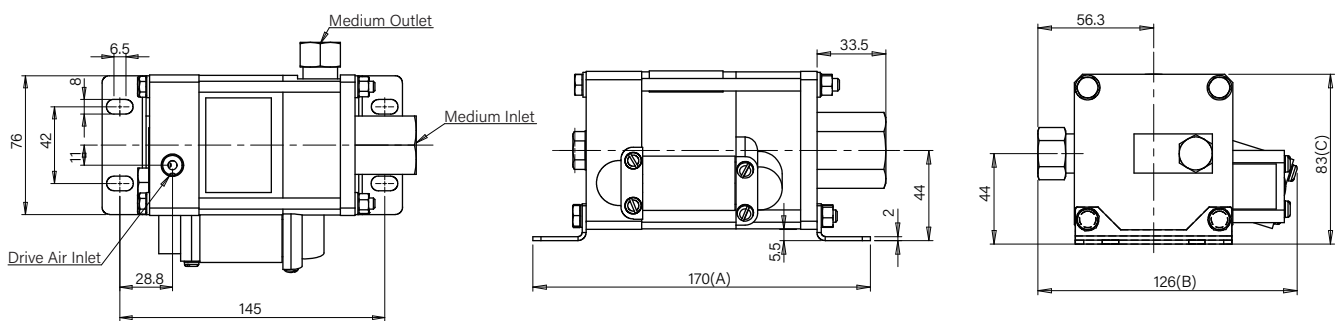

Selection of HiFluid Air Driven Liquid Pumps—S Series

The S series Air Driven Liquid Pumps are only available in single-drive single-acting type. It provides seven pressure ratios to adapt to different pressure requirements. It is characterized by low energy consumption and high output pressure, which is suitable for working scenarios with high pressure but low flow requirements.

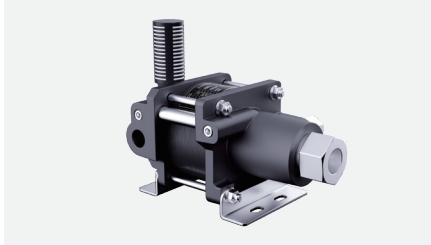

S Series Single-Drive Single-Acting Air Driven Liquid Pump

- Single-Drive Piston, Single-Acting
- Maximum Output Pressure: 72.1MPa (10,455psi)
- Suitable for Air Drive Pressure (P_L) at 0.3 to 0.7MPa (43.5 to 101.5psi)
- Actual Output Pressure = Air Drive Pressure * Pressure Ratio
- Suitable for water, oil, solvents, low-corrosive chemicals, liquefied gases, and other liquid fluids.

Product Parameters

Type	Pressure Ratio	Displacement /Cycle (ml)	Max. Outlet Pressure		Flow Rate (L/min)	Connection Interface			Dimensions (mm)			Weight (kg)
			MPa	psi		Drive Inlet	Medium Inlet	Medium Outlet	A	B	C	
HFLS-16	1:16	14.48	11.2	1624	6.89	NPT1/2	NPT3/4	NPT1/2	225	155	188	4.8
HFLS-25	1:25	9.27	17.5	2538	4.4	NPT1/2	NPT3/4	NPT1/2	225	155	188	4.8
HFLS-31	1:31	7.51	21.7	3147	3.57	NPT1/2	NPT3/4	NPT1/2	225	155	188	4.8
HFLS-40	1:40	5.93	28	4060	2.82	NPT1/2	NPT1/2	NPT1/4	225	155	188	4.8
HFLS-52	1:52	4.54	36.4	5278	2.16	NPT1/2	NPT1/2	NPT1/4	225	155	188	4.8
HFLS-71	1:71	3.34	49.7	7206	1.57	NPT1/2	NPT1/2	NPT1/4	225	155	188	4.8
HFLS-103	1:103	2.32	72.1	10455	1.1	NPT1/2	NPT1/2	NPT1/4	225	155	188	4.8

Installation Dimensions

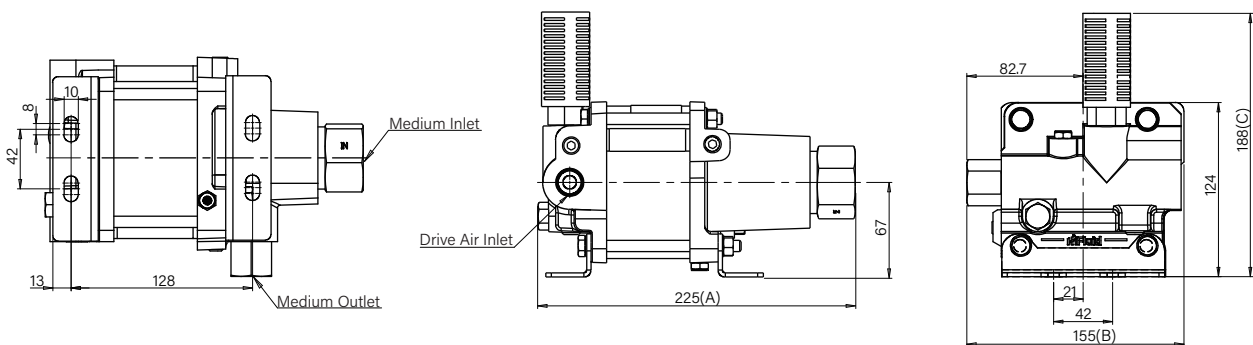

Selection of HiFluid Air Driven Liquid Pumps—G Series

The G series Air Driven Liquid Pumps are available in three types: single-drive single-acting, single-drive double-acting, and double-drive single-acting, which provide a variety of pressure ratios and are characterized by low energy consumption and high output pressure, and are suitable for working scenarios with high pressure and flow requirements.

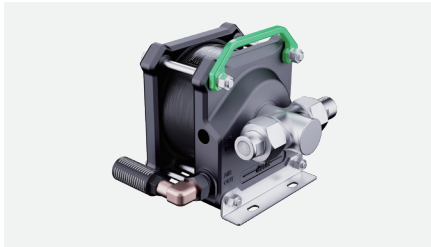

G Series Single-Drive Single-Acting Air Driven Liquid Pump

- Single-Drive Piston, Single-Acting
- Maximum Output Pressure: 320MPa (46,400psi)
- Suitable for Air Drive Pressure (P_L) at 0.3 to 0.8MPa (43.5 to 116psi)
- Actual Output Pressure = Air Drive Pressure * Pressure Ratio
- Suitable for water, oil, solvents, low-corrosive chemicals, liquefied gases, and other liquid fluids.

Product Parameters

Type	Pressure Ratio	Displacement /Cycle (ml)	Max. Outlet Pressure		Flow Rate (L /min)	Connection Interface			Dimensions (mm)			Weight (kg)
			MPa	psi		Drive Inlet	Medium Inlet	Medium Outlet	A	B	C	
HFLG-10	1:11	80	8.8	1276	18.4	NPT1/2	NPT1	NPT1/2	250	256	230	14
HFLG-16	1:16	55	12.8	1856	12.6	NPT1/2	NPT1	NPT1/2	250	256	230	14
HFLG-28	1:28	31	22.4	3248	7.13	NPT1/2	NPT1/2	NPT1/2	250	256	230	14
HFLG-40	1:40	22	32	4640	5.06	NPT1/2	NPT1/2	NPT1/2	250	256	230	14
HFLG-64	1:64	14	51.2	7424	3.22	NPT1/2	NPT1/2	NPT1/2	250	256	230	13
HFLG-80	1:80	11	64	9280	2.53	NPT1/2	NPT1/2	NPT1/2	250	256	230	13
HFLG-100	1:100	9	80	11600	2.07	NPT1/2	NPT1/2	NPT1/2	250	256	230	13
HFLG-130	1:130	6.8	104	15080	1.56	NPT1/2	NPT1/2	NPT1/2	250	256	230	13
HFLG-175	1:175	5	140	20300	1.15	NPT1/2	NPT1/2	HP1/4	250	256	230	12
HFLG-255	1:255	3.5	204	29580	0.8	NPT1/2	NPT1/2	HP1/4	250	256	230	12
HFLG-400	1:400	2.2	320	46400	0.5	NPT1/2	NPT1/2	HP1/4	250	256	230	12

Installation Dimensions

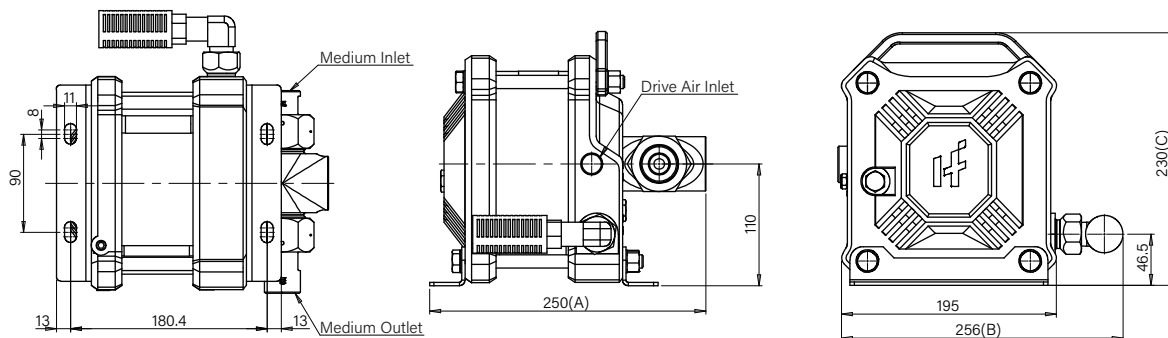

Selection of HiFluid Air Driven Liquid Pumps—G Series

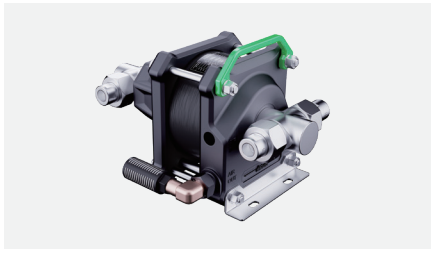

G Series Single-Drive Double-Acting Air Driven Liquid Pump

- Single-drive piston, double-acting, with a flow rate nearly 50% higher than single-acting models.
- Maximum Output Pressure: 80MPa (11,600psi)
- Suitable for Air Drive Pressure (P_L) at 0.3 to 0.8MPa (43.5 to 116psi)
- Actual Output Pressure = Air Drive Pressure * Pressure Ratio
- Suitable for water, oil, solvents, low-corrosive chemicals, liquefied gases, and other liquid fluids.

Product Parameters

Type	Pressure Ratio	Displacement /Cycle (ml)	Max. Outlet Pressure		Flow Rate (L/min)	Connection Interface			Dimensions (mm)			Weight (kg)
			MPa	psi		Drive Inlet	Medium Inlet	Medium Outlet	A	B	C	
HFLG-10D	1:11	160	8.8	1276	27.6	NPT1/2	NPT1	NPT1/2	377	256	230	19
HFLG-16D	1:16	110	12.8	1856	18.9	NPT1/2	NPT1	NPT1/2	377	256	230	19
HFLG-28D	1:28	62	22.4	3248	10.7	NPT1/2	NPT1/2	NPT1/2	377	256	230	19
HFLG-40D	1:40	44	32	4640	7.59	NPT1/2	NPT1/2	NPT1/2	377	256	230	19
HFLG-64D	1:64	28	51.2	7424	4.83	NPT1/2	NPT1/2	NPT1/2	377	256	230	18
HFLG-80D	1:80	22	64	9280	3.81	NPT1/2	NPT1/2	NPT1/2	377	256	230	18
HFLG-100D	1:100	18	80	11600	3.11	NPT1/2	NPT1/2	NPT1/2	377	256	230	18

Installation Dimensions

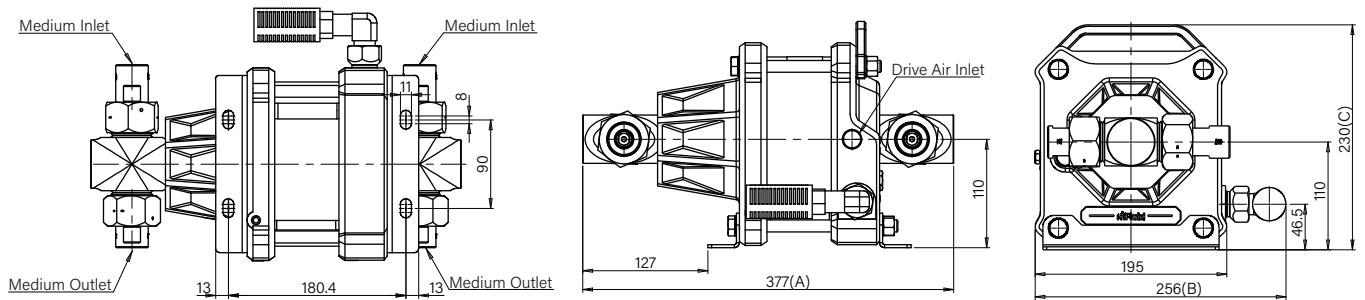

Selection of HiFluid Air Driven Liquid Pumps—G Series

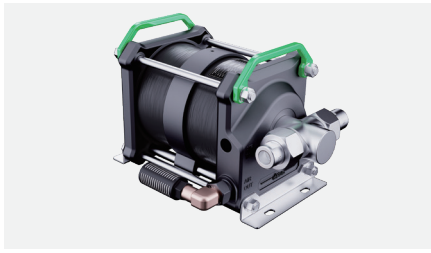

G Series Double-Drive Single-Acting Air Driven Liquid Pump

- Double-drive piston, single-acting, with output pressure nearly twice that of single-drive piston.
- Maximum Output Pressure: 600MPa (87,000psi)
- Suitable for Air Drive Pressure (P_L) at 0.3 to 0.8MPa (43.5 to 116psi)
- Actual Output Pressure = Air Drive Pressure * Pressure Ratio
- Suitable for water, oil, solvents, low-corrosive chemicals, liquefied gases, and other liquid fluids.

Product Parameters

Type	Pressure Ratio	Displacement /Cycle (ml)	Max. Outlet Pressure		Flow Rate (L/min)	Connection Interface			Dimensions (mm)			Weight (kg)
			MPa	psi		Drive Inlet	Medium Inlet	Medium Outlet	A	B	C	
HFLG-10-2	1:22	80	17.6	2552	18.4	NPT1/2	NPT1/2	NPT1/2	356	256	230	21
HFLG-16-2	1:32	55	25.6	3712	12.65	NPT1/2	NPT1/2	NPT1/2	356	256	230	21
HFLG-28-2	1:56	31	44.8	6496	7.13	NPT1/2	NPT1/2	NPT1/2	356	256	230	21
HFLG-40-2	1:80	22	64	9280	5.06	NPT1/2	NPT1/2	NPT1/2	356	256	230	21
HFLG-64-2	1:128	14	102.4	14848	3.22	NPT1/2	NPT1/2	NPT1/2	356	256	230	20
HFLG-80-2	1:160	11	128	18560	2.53	NPT1/2	NPT1/2	HP1/4	356	256	230	20
HFLG-100-2	1:200	9	160	23200	1.78	NPT1/2	NPT1/2	HP1/4	356	256	230	20
HFLG-130-2	1:260	6.8	208	30160	1.34	NPT1/2	NPT1/2	HP1/4	356	256	230	20
HFLG-175-2	1:350	5	280	40600	0.99	NPT1/2	NPT1/2	HP1/4	356	256	230	19
HFLG-255-2	1:510	3.5	408	59160	0.69	NPT1/2	NPT1/2	HP1/4	356	256	230	19
HFLG-400-2	1:800	2.2	600	87000	0.43	NPT1/2	NPT1/2	HP1/4	356	256	230	19

Installation Dimensions

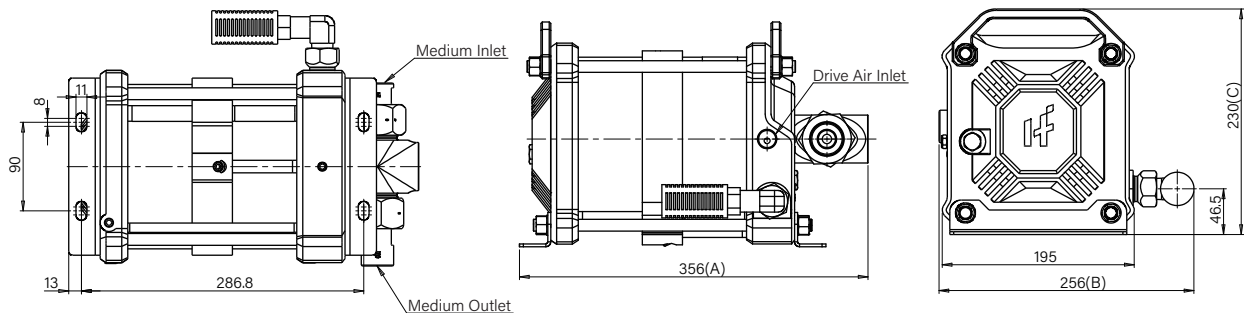

Selection of HiFluid Air Driven Liquid Pumps—G Series

The G-D Air Driven Liquid Pumps is specially designed with a distance piece between the air drive chamber and the gas boosting chamber. This design effectively prevents potential cross-contamination. In the event of leakage, it allows for timely observation and detection. This isolation measure not only ensures the quality of the liquid but also enhances the overall safety of the system, making the G-D air drive liquid pump ideal for applications with strict purity requirements.

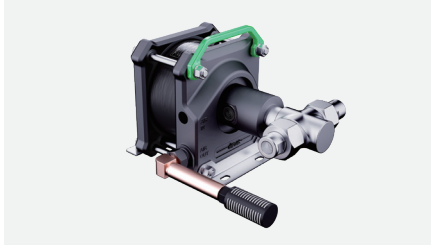

G-D Air Driven Liquid Pump

- Single-Drive Piston, Single-Acting
- Maximum Output Pressure: 320MPa (46,400psi)
- Suitable for Air Drive Pressure (P_L) at 0.3 to 0.8MPa (43.5 to 116psi)
- Actual Output Pressure = Air Drive Pressure * Pressure Ratio
- Suitable for water, oil, solvents, low-corrosive chemicals, liquefied gases, and other liquid fluids.

Product Parameters

Type	Pressure Ratio	Displacement /Cycle (ml)	Max. Outlet Pressure		Flow Rate (L/min)	Connection Interface			Dimensions (mm)			Weight (kg)
			MPa	psi		Drive Inlet	Medium Inlet	Medium Outlet	A	B	C	
HFLG-D10	1:11	80	8.8	1276	18.4	NPT1/2	NPT1	NPT1/2	350	256	230	14
HFLG-D16	1:16	55	12.8	1856	12.6	NPT1/2	NPT1	NPT1/2	350	256	230	14
HFLG-D28	1:28	31	22.4	3248	7.13	NPT1/2	NPT1/2	NPT1/2	350	256	230	14
HFLG-D40	1:40	22	32	4640	5.06	NPT1/2	NPT1/2	NPT1/2	350	256	230	14
HFLG-D64	1:64	14	51.2	7424	3.22	NPT1/2	NPT1/2	NPT1/2	350	256	230	13
HFLG-D80	1:80	11	64	9280	2.53	NPT1/2	NPT1/2	NPT1/2	350	256	230	13
HFLG-D100	1:100	9	80	11600	2.07	NPT1/2	NPT1/2	NPT1/2	350	256	230	13
HFLG-D130	1:130	6.8	104	15080	1.56	NPT1/2	NPT1/2	NPT1/2	350	256	230	13
HFLG-D175	1:175	5	140	20300	1.15	NPT1/2	NPT1/2	HP1/4	350	256	230	12
HFLG-D255	1:255	3.5	204	29580	0.8	NPT1/2	NPT1/2	HP1/4	350	256	230	12
HFLG-D400	1:400	2.2	320	46400	0.5	NPT1/2	NPT1/2	HP1/4	350	256	230	12

Installation Dimensions

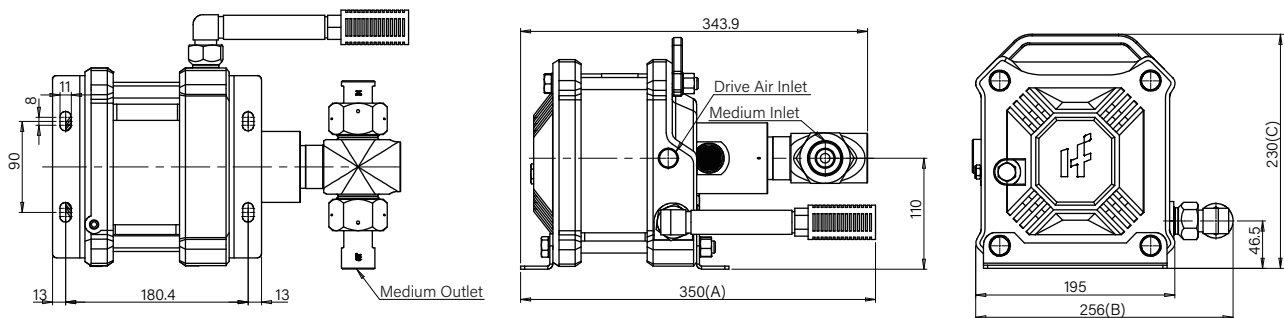

Selection of HiFluid Air Driven Liquid Pumps

Based on the diameter size of the drive cylinder, HiFluid Air Driven Liquid Pumps are divided into three types: M series, S series, and G series. The main differences are as follows:

Series	Output Pressure	Size	Energy Consumption	Price
M Series	★★★	★★★	★★★	★★★
S Series	★★★★	★★★★	★★★★	★★★★
G Series	★★★★★	★★★★★	★★★★★	★★★★★

The selection of an air driven liquid pump is critical, and many factors need to be considered, including the following:

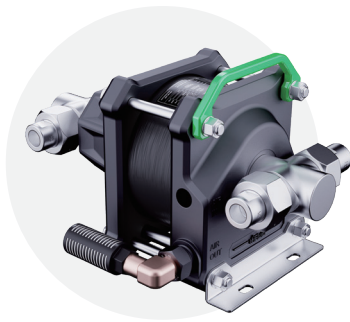

- ⑤ Medium Outlet Pressure P_B : The required medium outlet pressure.
- ⑤ Air Drive Pressure P_L : The compressed air pressure supplied to the air drive liquid pump.
- ⑤ Flow Q : The required output medium flow rate.
- ⑤ Medium: The medium's properties determine the sealing material. For special mediums, please consult HiFluid sales.

⑤ Medium Temperature: High or low medium temperatures will shorten the lifespan of the sealing components. We recommend controlling the temperature range at -10°C to 100°C . If the range is exceeded, please consult HiFluid sales.

⑤ Ambient Temperature: If used in extremely high or low temperatures, the air drive liquid pump may not function properly. We recommend controlling the ambient temperature at 0°C to 60°C . If the range is exceeded, please consult HiFluid sales.

⑤ Drive Air Quality: We recommend that the air quality meets at least ISO 8573-1 Class 4 standards.

Air Driven Liquid Pumps Selection Example 1

⊗ A customer requires an air driven liquid pump for water boosting. The specific working conditions are as follows:

Medium	Medium Outlet Pressure P_B	Flow Q	Air Drive Pressure P_L	Medium Temperature	Ambient Temperature
Water	35MPa	2.5L/min	0.7MPa	20°C	25°C

Based on the parameters provided by the customer, the boosting medium is identified as standard liquid "water"; both medium and ambient temperatures are within the normal range, allowing for further selection.

1. Minimum pressure ratio

● Minimum Pressure Ratio = Medium Outlet Pressure P_B / Air Drive Pressure P_L
 $= 35\text{MPa} / 0.7\text{MPa} = 50$

● Choose an air driven liquid pump with a pressure ratio greater than or close to 1:50. Specific models are as follows:

HFLM-76	HFLS-52	HFLG-64	HFLG-64D	HFLG-28-2	HFLG-D64
---------	---------	---------	----------	-----------	----------

2. Pump selection by considering flow rate

- The flow rate provided in HiFluid's parameter table is under conditions of 0 output pressure, 0.7MPa air drive pressure, and 1000L_N/min air consumption. Considering the pressure-flow relationship of air driven liquid pumps, to meet the requirement of 2.5L/min flow rate at 35MPa pressure, select an air drive liquid pump with a parameter showing a flow rate nearly 2 times larger than 2.5L/min. The specific model is:

HFLG-64D

Air Driven Liquid Pump Selection Example 2

A customer requires an air driven liquid pumps for components oil pressure testing, the specific working conditions are as follows:

Medium	Testing Pressure P _B (Medium Outlet Pressure)	Flow Q	Air drive pressure P _L	Component Volume	Boosting Time	Medium Temperature	Ambient Temperature
Oil	8MPa	None	0.6MPa	2L	2min	20°C	25°C

Based on the parameters provided by the customer, the boosting medium is identified as standard liquid "oil"; both medium and ambient temperatures are within the normal range, allowing for further selection.

1. Minimum pressure ratio

- Minimum Pressure Ratio = Medium Outlet Pressure P_B / Air Drive Pressure P_L
= 8MPa / 0.6MPa = 13.3
- Choose an air driven liquid pump with a pressure ratio greater than or close to 1:13.3. Specific models are as follows:

HFLM-15 HFLS-16 HFLG-16 HFLG-16D HFLG-D16 HFLG-16-2

2. Calculate the total medium volume required to fill the testing component under 8MPa pressure

- Medium Volume = Component Volume * (1+Medium Outlet Pressure P_B / (Elastic Modulus*0.8))
= Component Volume * (1+80 / (10,000*0.8))
= 2 * 1.01 = 2.02 (L)

Note: 0.8 is a correction factor considering the compressibility of the medium.

3. Calculate the theoretical boosting time

- Theoretical boosting time = Medium volume / (Air driven liquid pump flow rate/2)
 - HFLM-15:
2.02 / (3.25/2) = 1.24minutes
 - HFLS-16:
2.02 / (6.89/2) = 0.59minutes
 - HFLG-16:
2.02 / (12.6/2) = 0.32minutes
 - HFLG-16D:
2.02 / (18.9/2) = 0.2minutes
 - HFLG-D16:
2.02 / (12.6/2) = 0.32minutes
 - HFLG-16-2:
2.02 / (10.84/2) = 0.37minutes
- According to the calculations, all of the air driven liquid pumps above can meet the time requirement, and the customer can select the most suitable air drive liquid pump based on actual application conditions.

01 Preparation Work

Check and ensure the air driven liquid pump's model, parameters match the actual application requirements. Confirm that the pump and its components are undamaged during transport.

02 Select Installation Location

Choose a flat surface capable of bearing the pump's weight. Ensure the environment is dry and well-ventilated, with enough space for operation. Avoid extreme temperatures, humidity, or corrosive gases.

03 Installation Foundation

Fix the air driven liquid pump to the equipment using appropriate bolts and nuts to minimize vibration and movement. In general, the air inlet is positioned on the top, and the medium inlets/outlets at the bottom (vertical installation). This setup helps protect the seals, extending the pump's lifespan.

04 Connect the Compressed Air

Ensure the compressed air is clean. Use air filters, pressure regulators, lubricators, and high-quality piping and fittings. The air pressure should meet the pump's requirements (usually 0.3-0.8MPa), and air quality should meet at least ISO 8573-1 Class 4.

05 Connect the Gas Pipeline

Select corrosion-resistant, pressure-resistant piping material based on the medium properties and ensure a secure connection of the medium inlet pipe. It is recommended that the pipe size connected to the pump is larger than the booster interface size to ensure smooth medium flow and reduce energy loss.

06 Start

Open the compressed air valve and gradually increase the air pressure until the pump starts operating. Observe whether the start is smooth, without abnormal vibrations or noise.

07 Observe

Monitor the medium flow and pressure. If any abnormalities are observed, immediately stop the pump and inspect.

08 Adjustment

Adjust the air pressure as needed to achieve different output pressures and flow rates.

09 Stop

Gradually reduce the air pressure and close the air valve. For long periods of inactivity, drain any remaining medium from the pump to prevent corrosion and scaling.

Pressure-Flow Rate Curves of HiFluid Air Driven Liquid Pumps HIFLUID

M Series

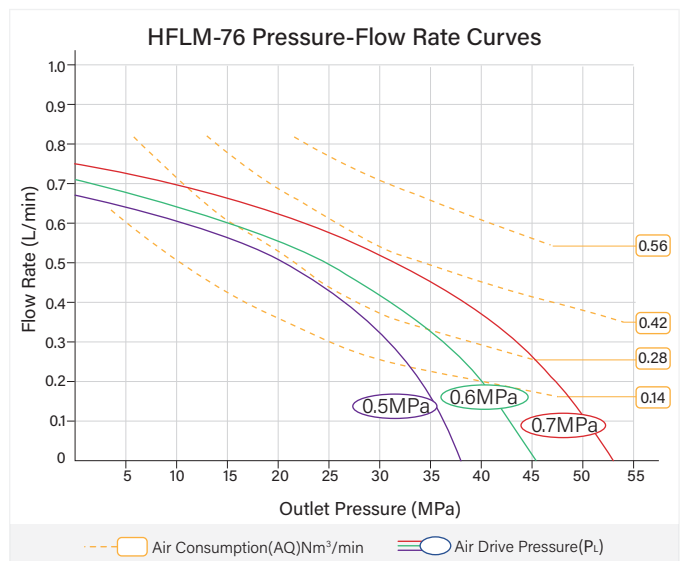
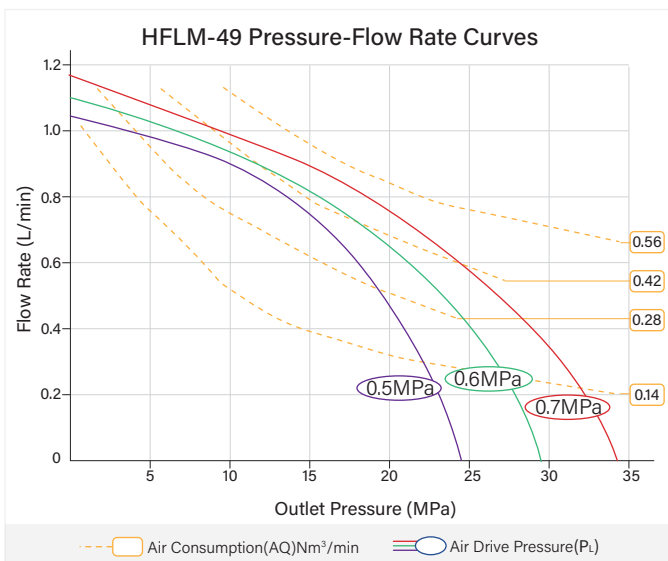
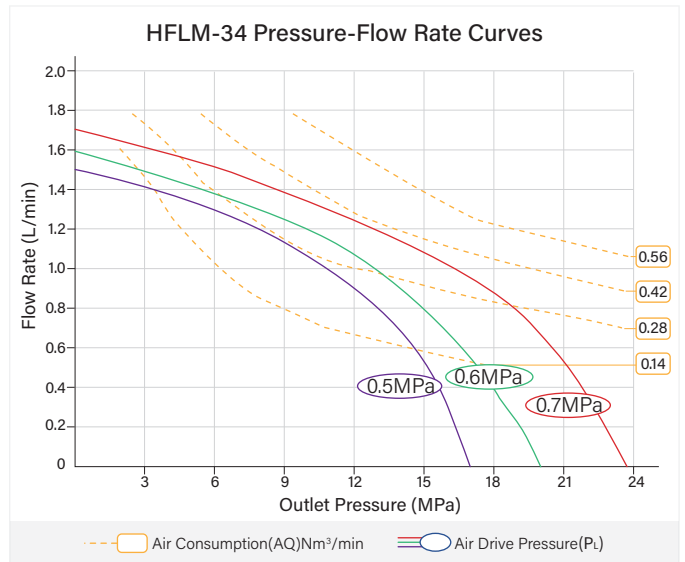
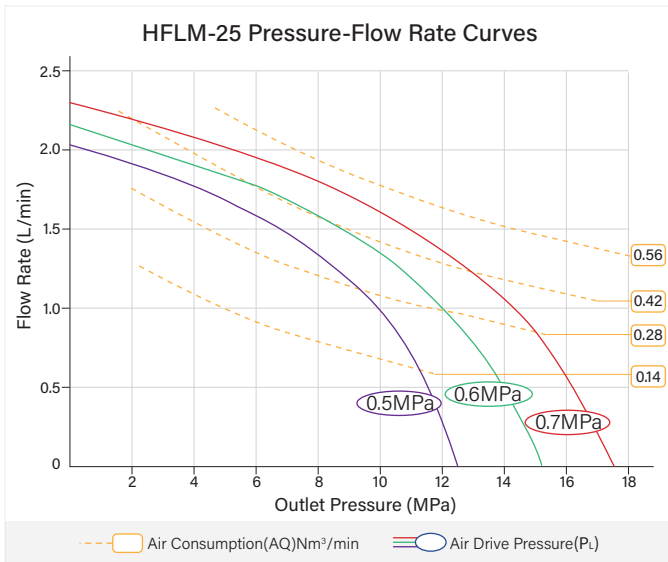
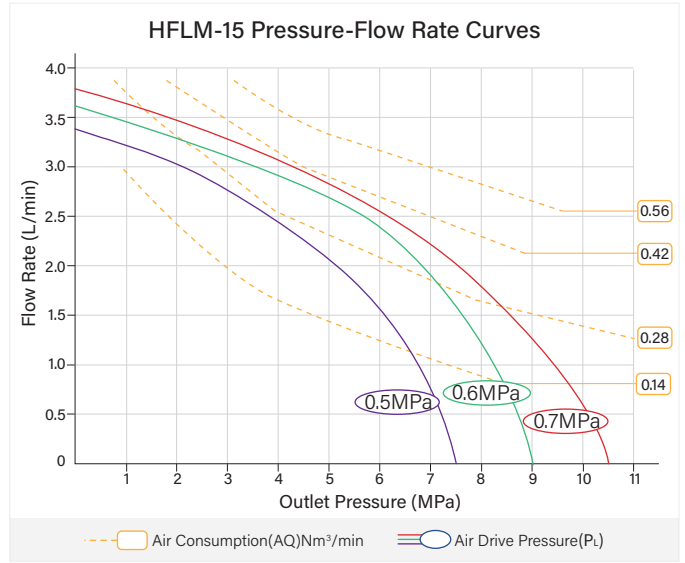
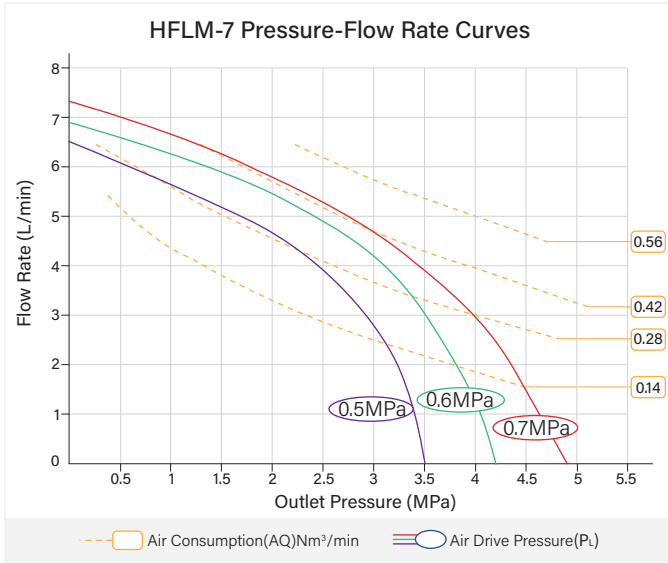

Pressure-Flow Rate Curves of HiFluid Air Driven Liquid Pumps HIFLUID

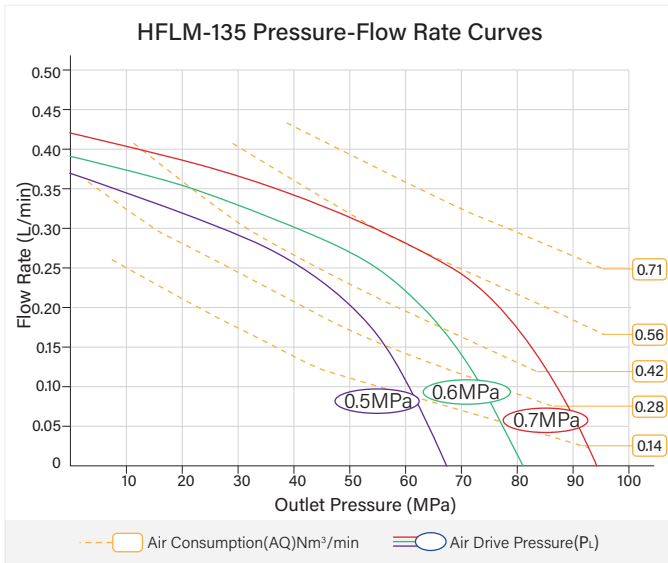

S Series

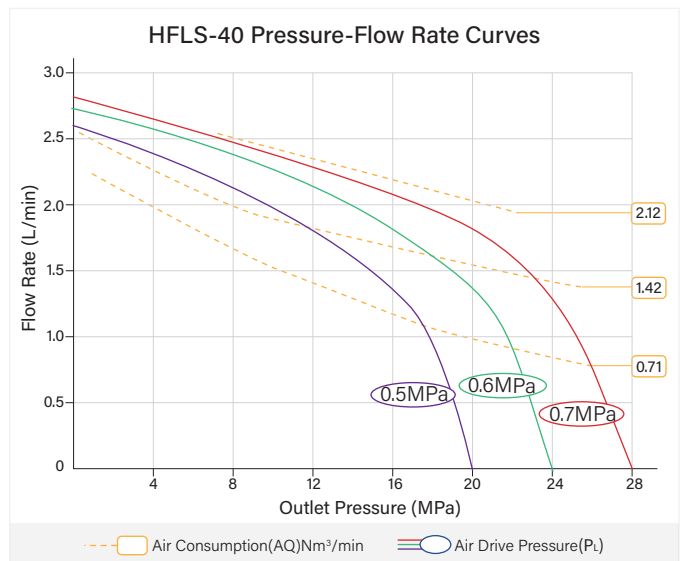
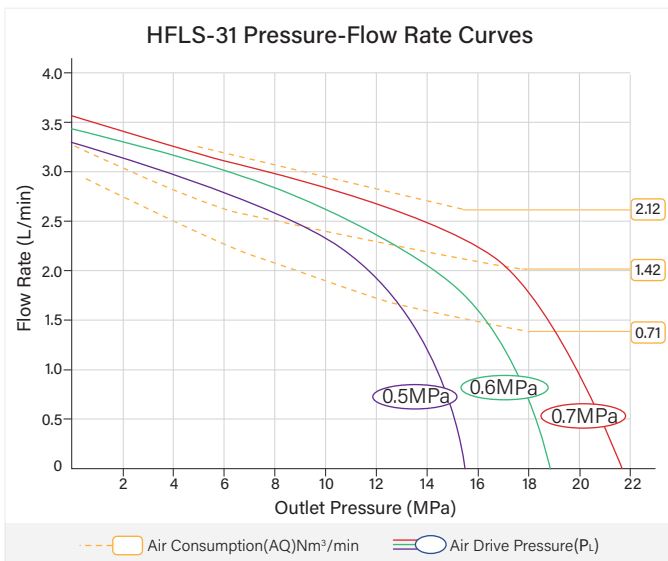
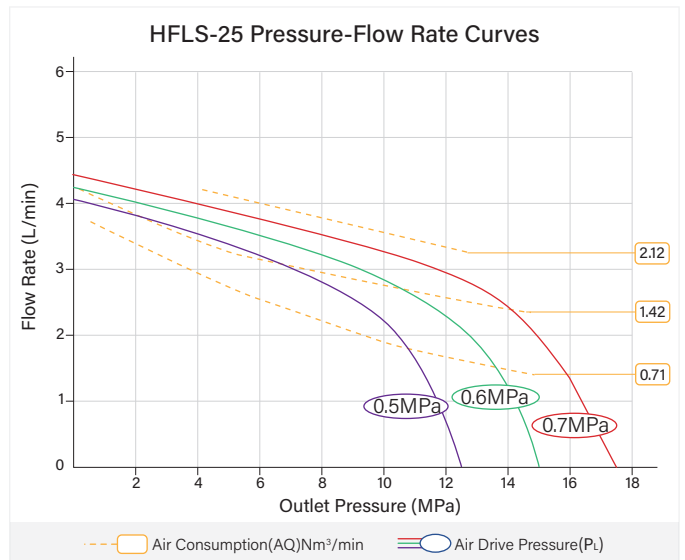
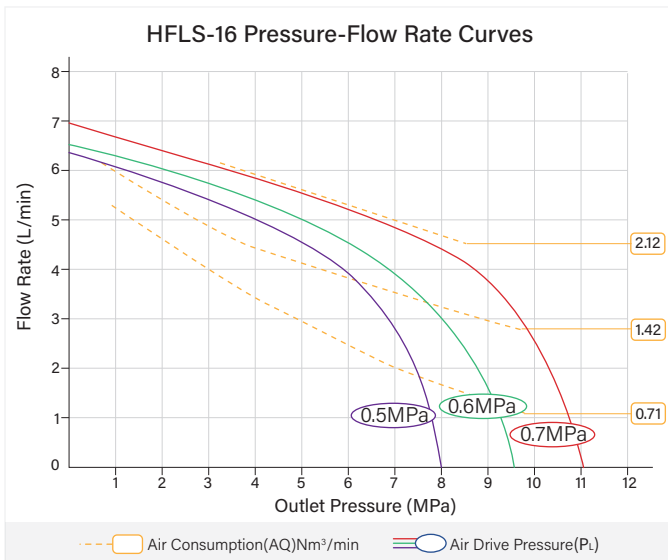

Pressure-Flow Rate Curves of HiFluid Air Driven Liquid Pumps HIFLUID

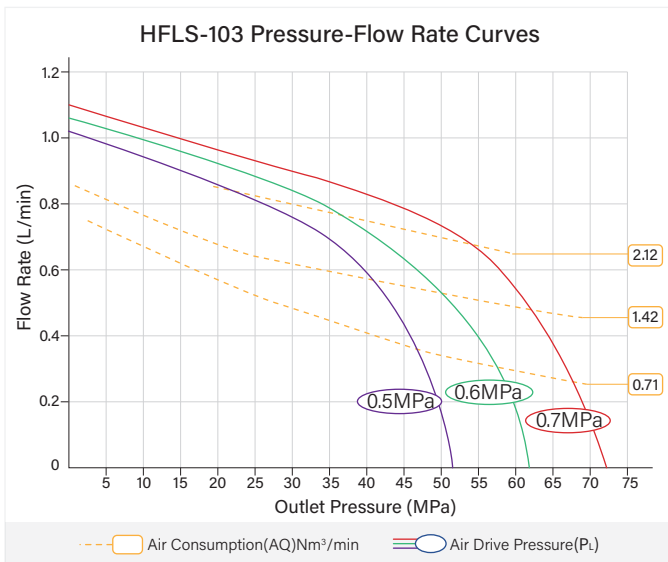
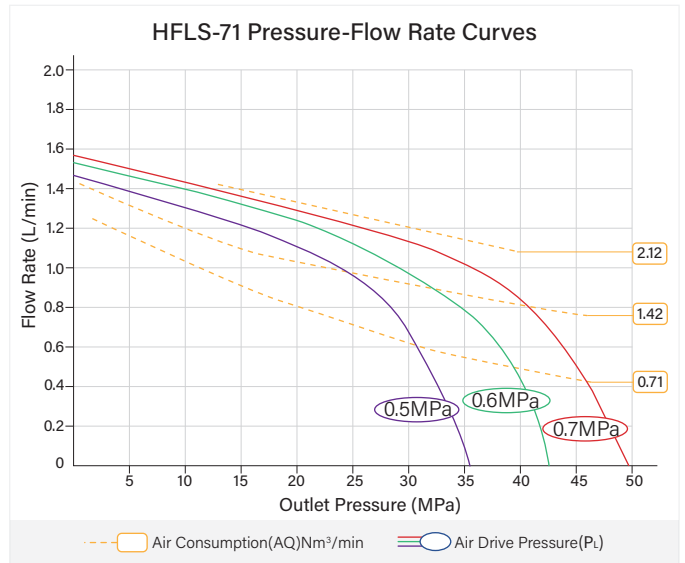
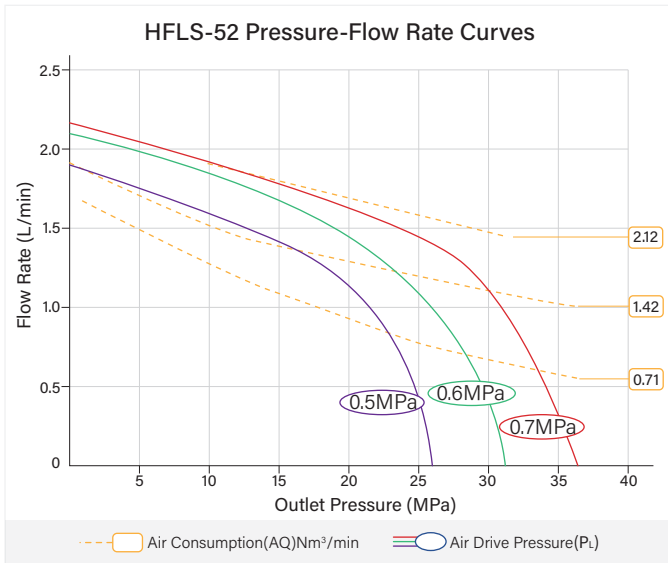

G Series Single-Drive Single-Acting

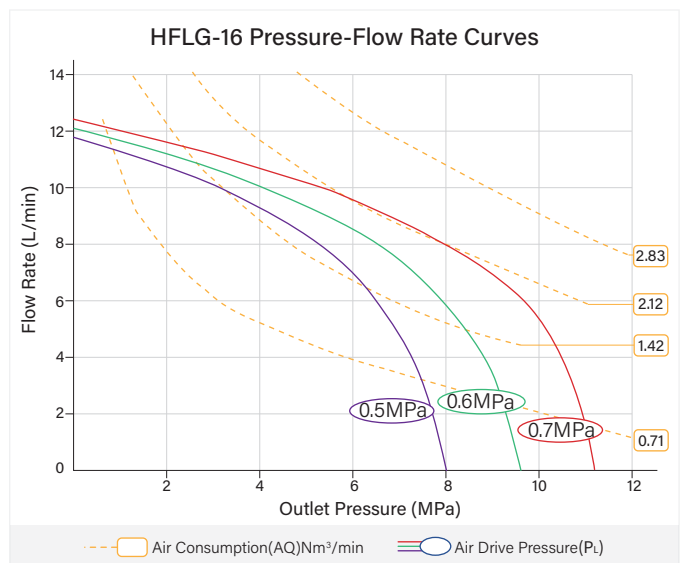
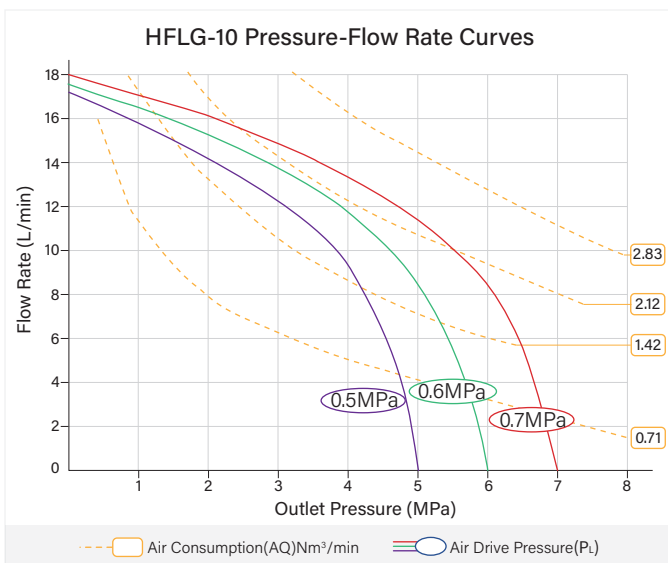

Pressure-Flow Rate Curves of HiFluid Air Driven Liquid Pumps HIFLUID

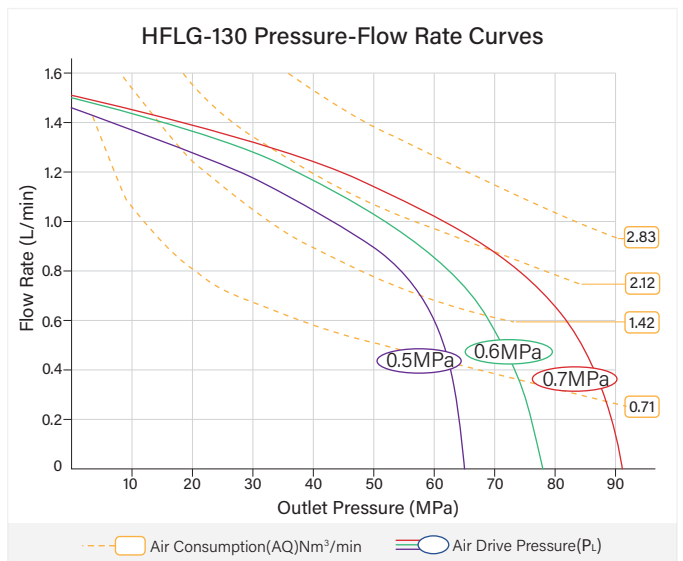
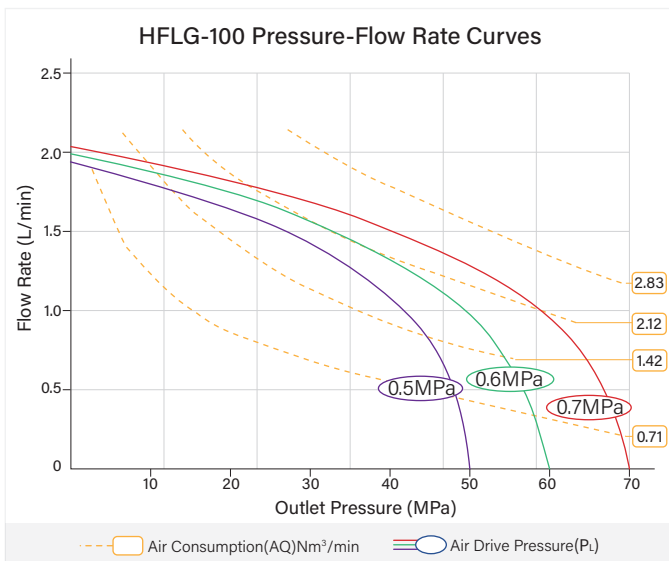
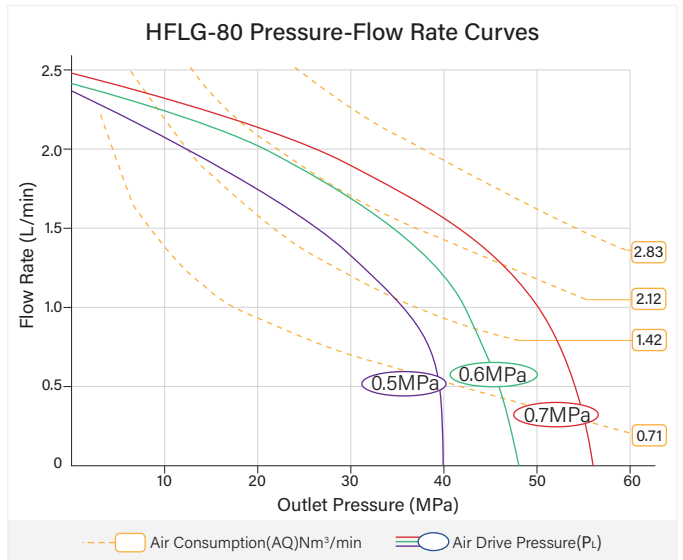
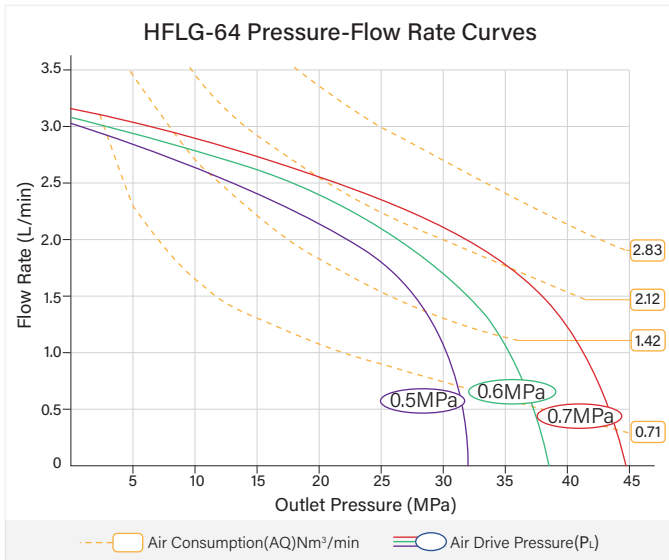
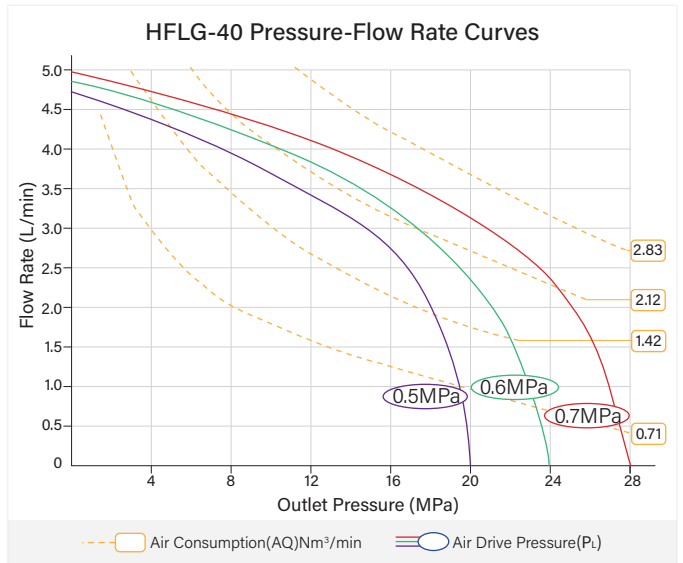
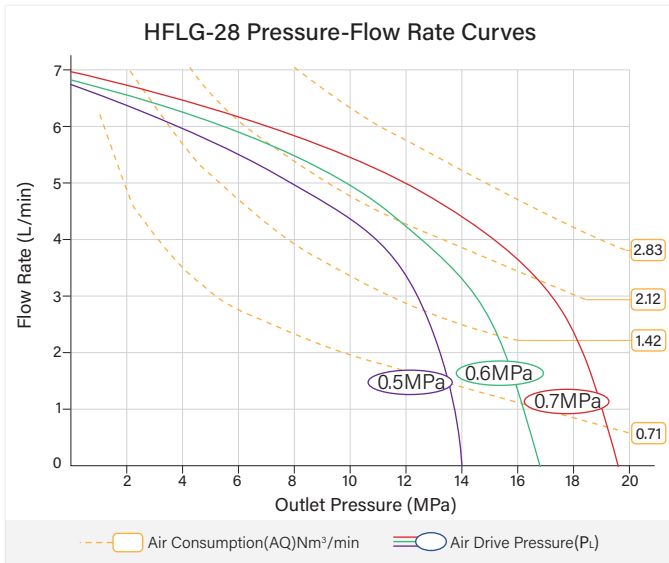

Pressure-Flow Rate Curves of HiFluid Air Driven Liquid Pumps HIFLUID

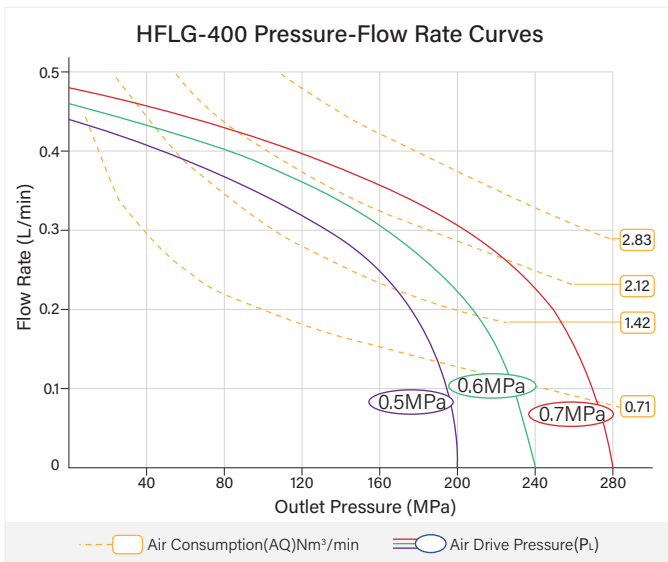
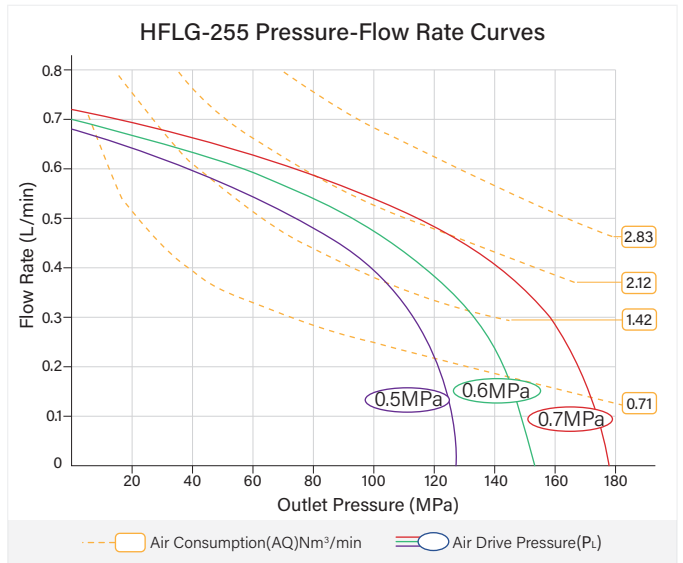
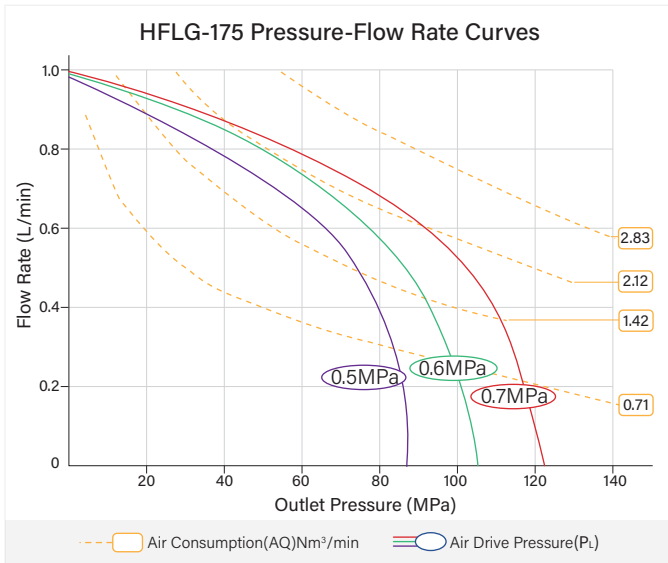

G Series Single-Drive Double-Acting

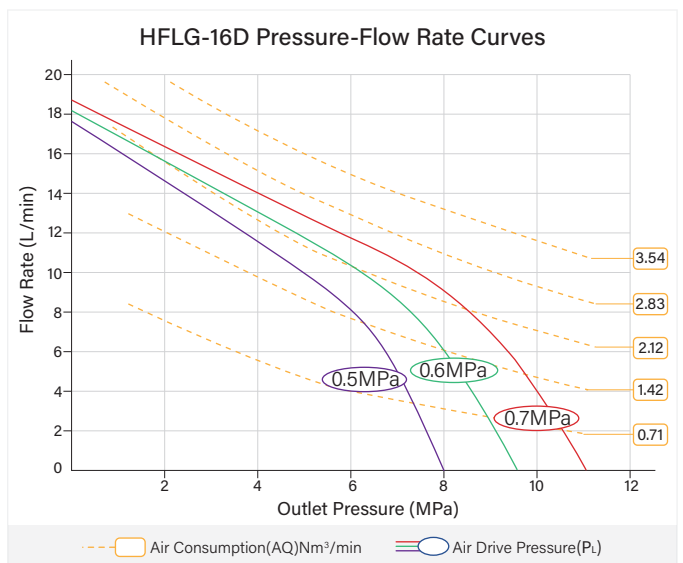
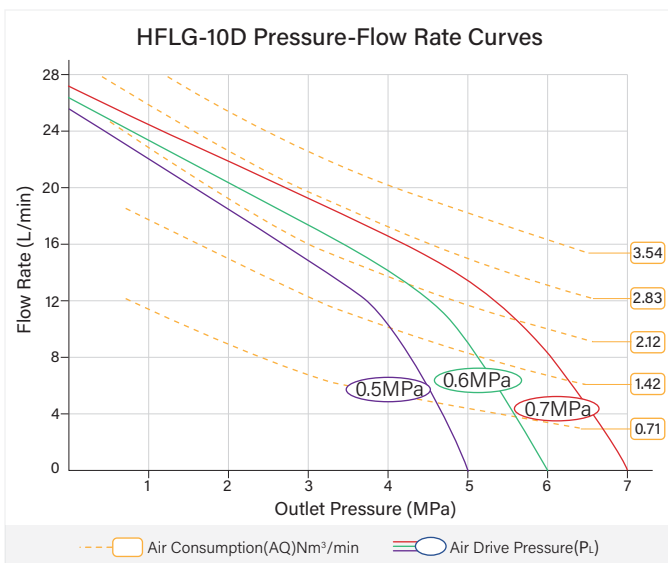

Pressure-Flow Rate Curves of HiFluid Air Driven Liquid Pumps HIFLUID

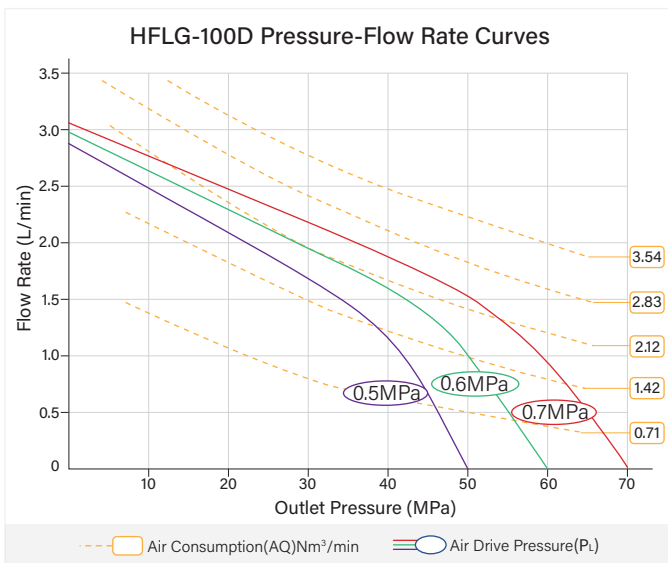
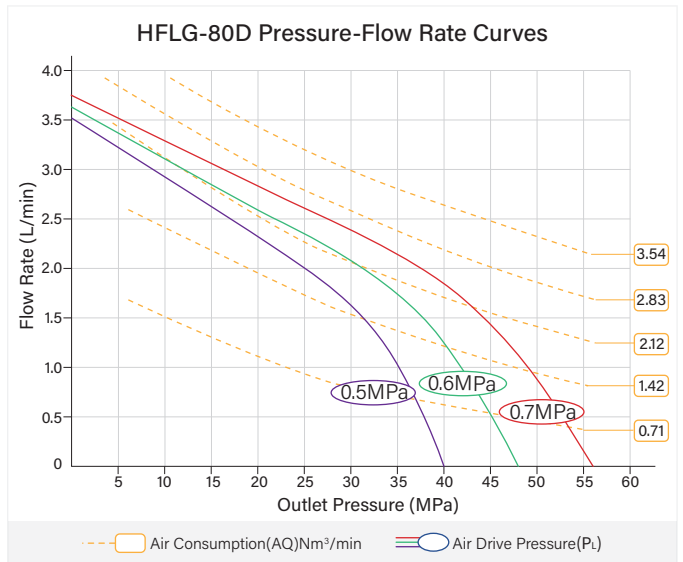
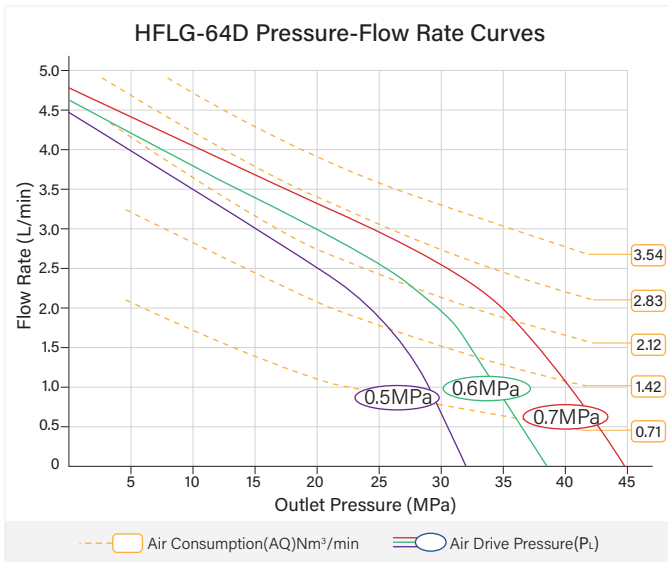
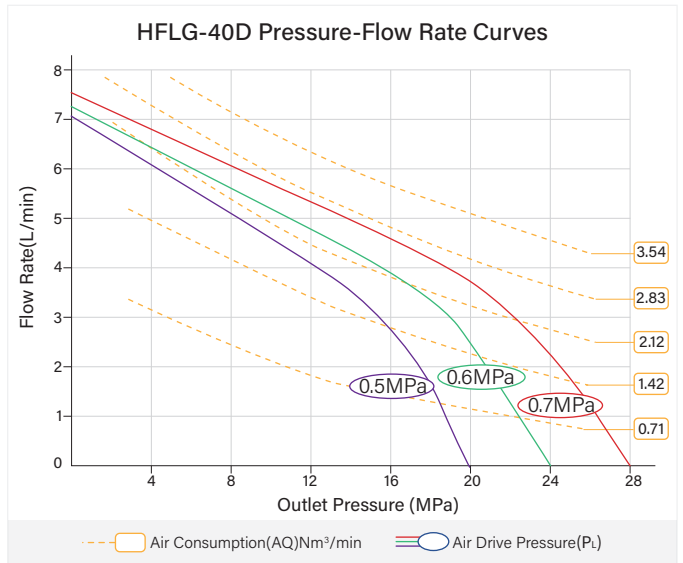
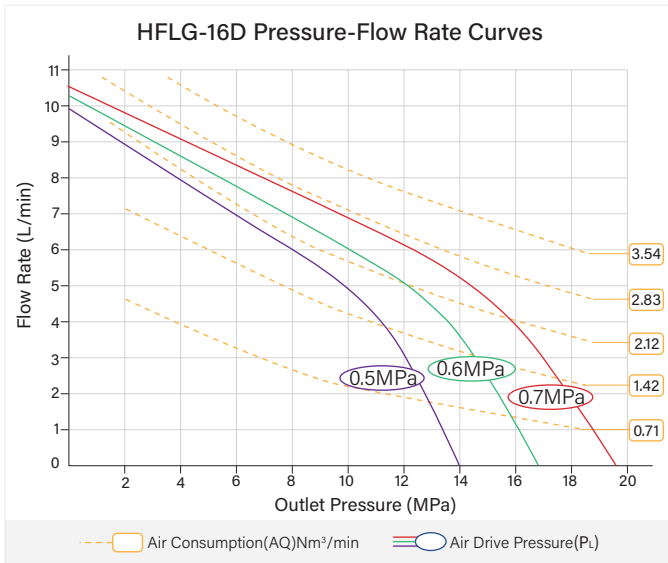

Pressure-Flow Rate Curves of HiFluid Air Driven Liquid Pumps HIFLUID

G Series Double-Drive Single-Acting

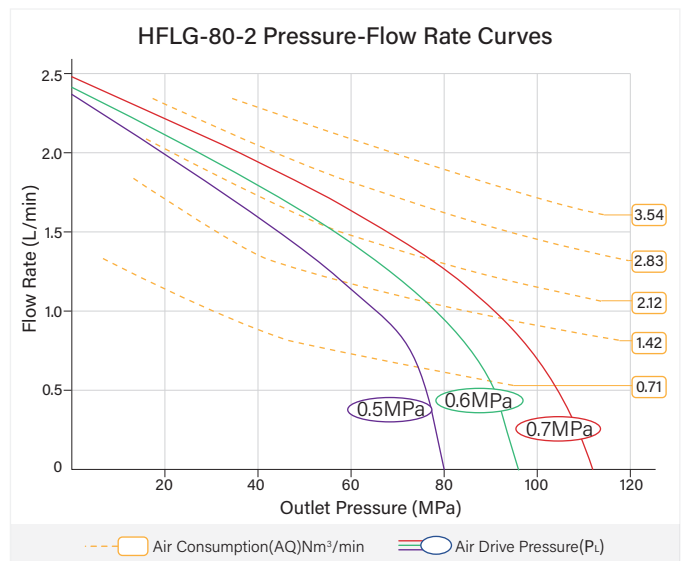
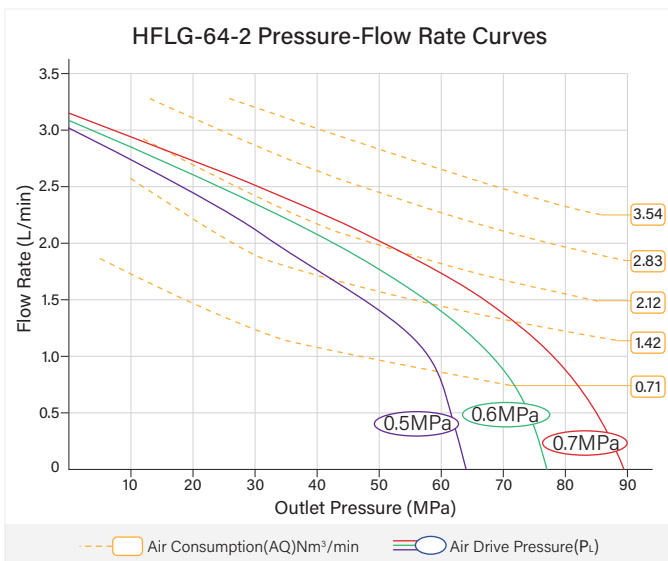
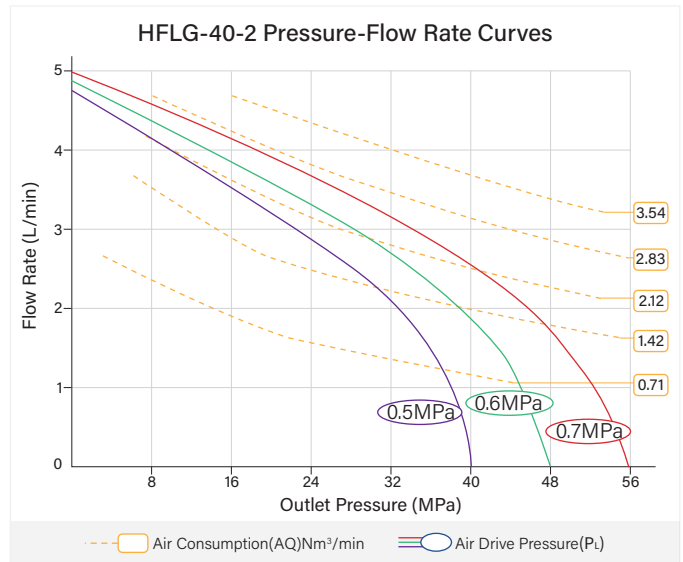
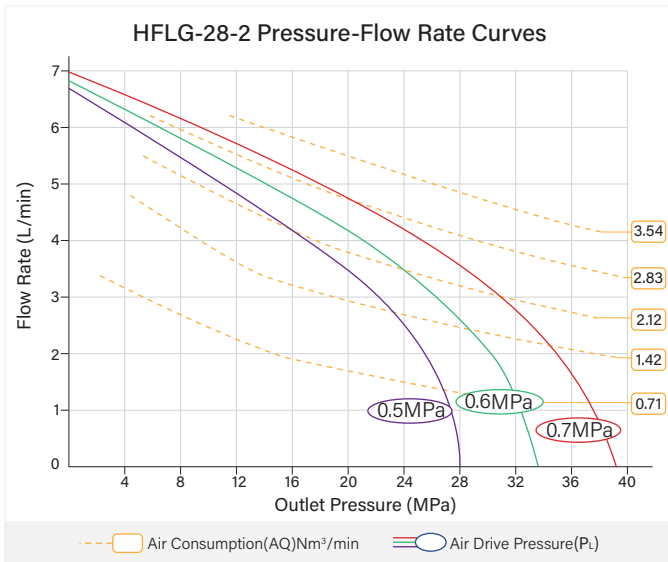
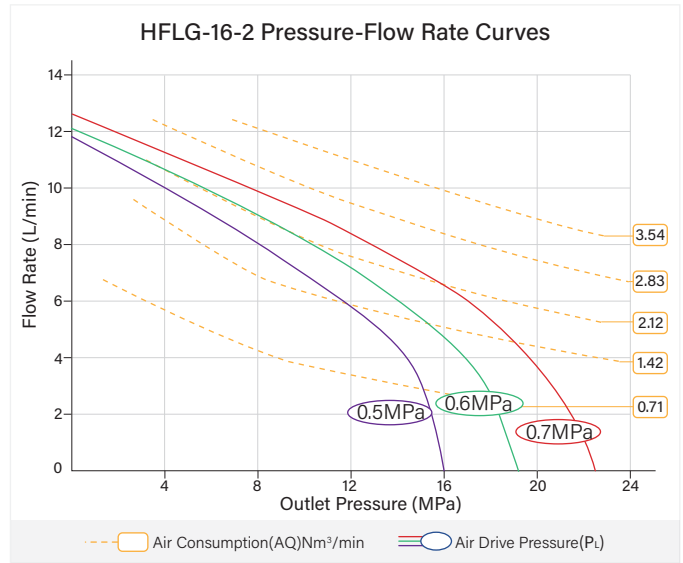
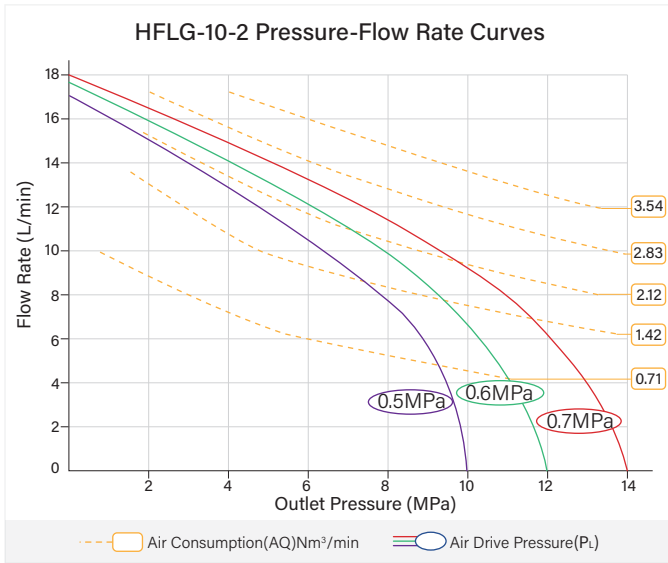

Pressure-Flow Rate Curves of HiFluid Air Driven Liquid Pumps HIFLUID

